

Standardowe profile kół zębanych / Standard profiles of timing pulleys

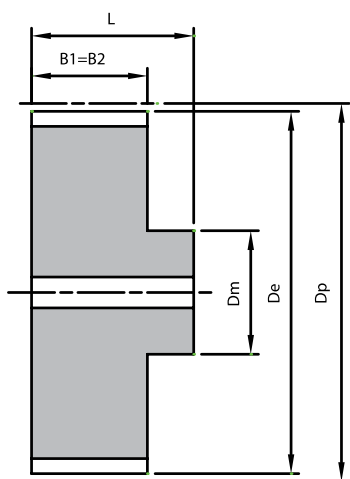

A

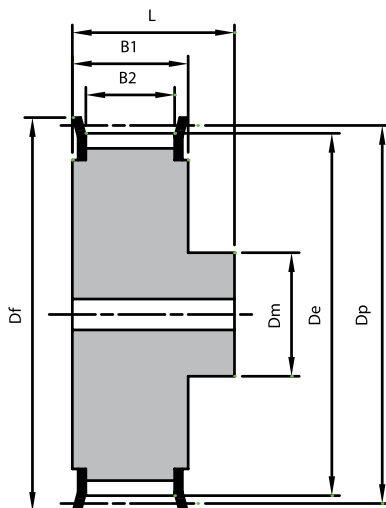

AF

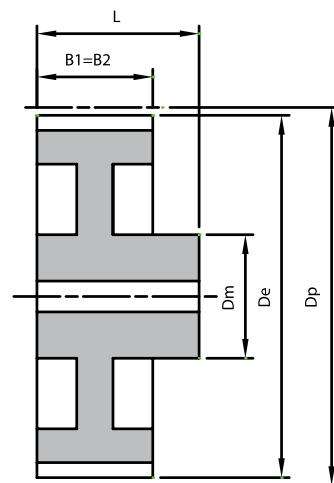

B

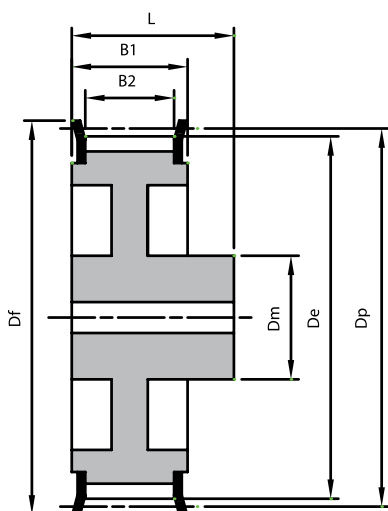

BF

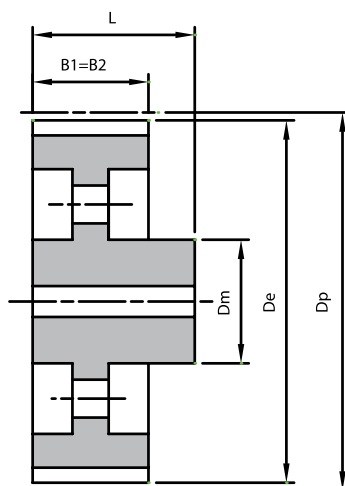

C

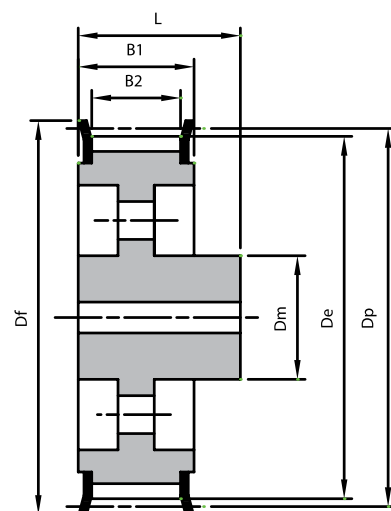

CF

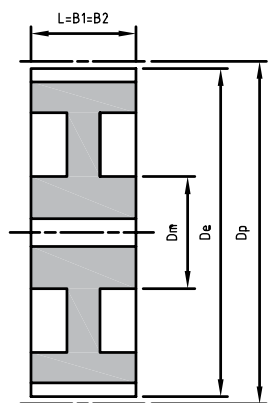

SB

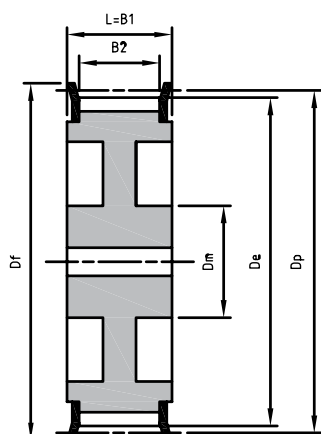

SBF

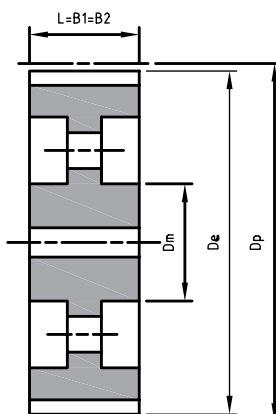

SC

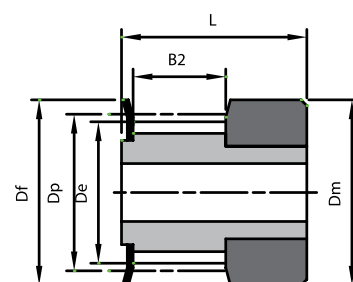

1F

Standardowe profile kół zębatych / Standard profiles of timing pulleys

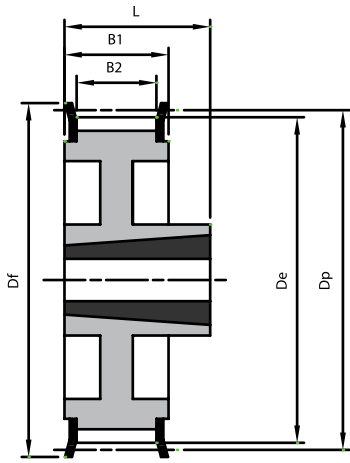

8WF

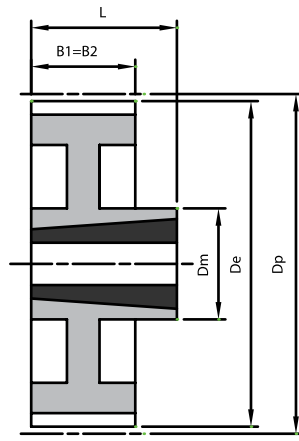

8W

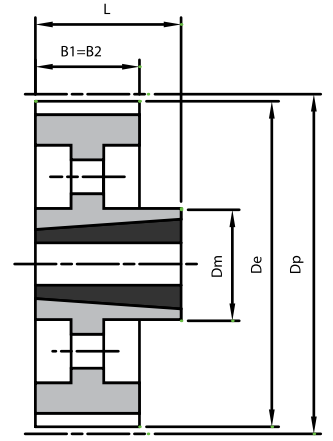

8A

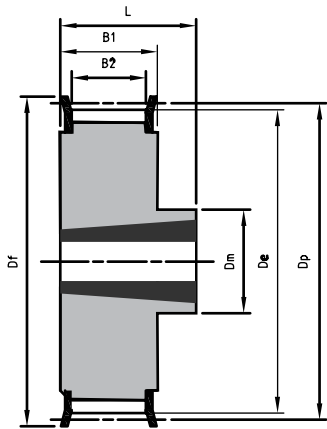

8F

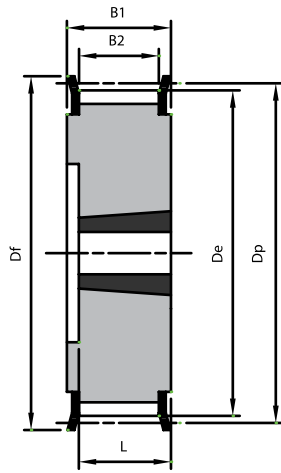

5F

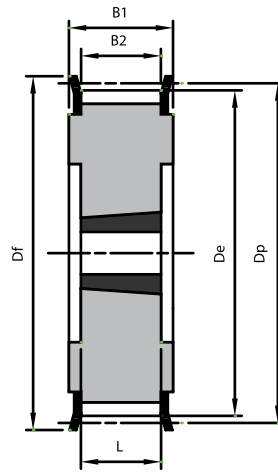

4F

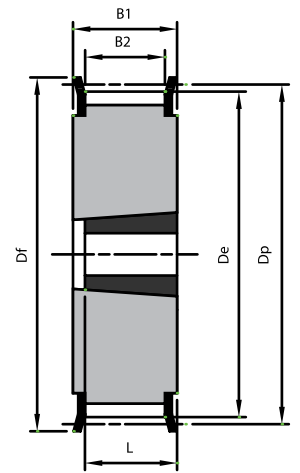

3F

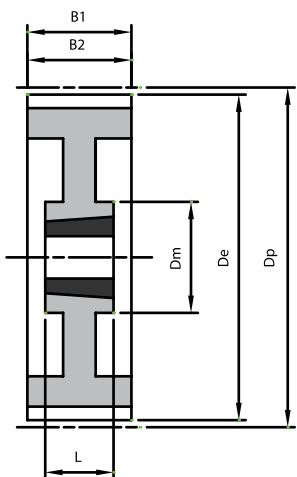

9W

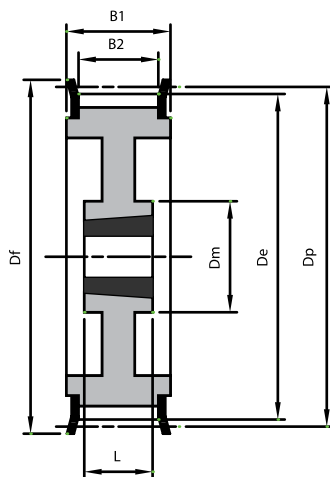

9WF

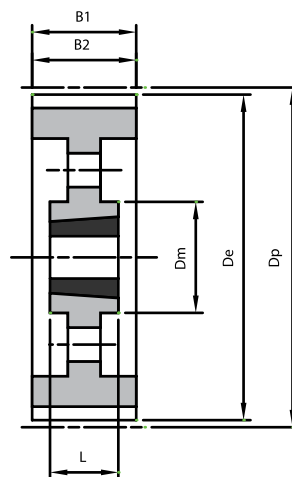

9A

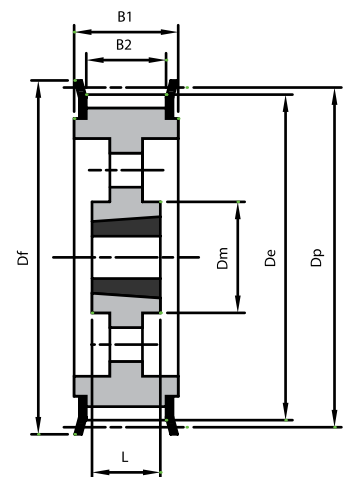

9AF